









Weiteres mögliches Zubehör:

- | | | | | | | | |
|-------------------------------------------------------------------------------------|-------------------------------------------------------------------------------------|-------------------------------------------------------------------------------------|-------------------------------------------------------------------------------------|---------------------------------------------------------------------------------------|---------------------------------------------------------------------------------------|---------------------------------------------------------------------------------------|---------------------------------------------------------------------------------------|
|  |  |  |  |  |  |  |  |
| MKA
f. Typ R
Montagekonsole | HB
f. Typ RS
Haltebügel | BG
Berührschutzgitter | GS
Geräteaus-
schalter | ED
Elektronisches
Steuergerät
(stufenlos) | RE / RTE
Steuergerät
(5-Stufen) | TE
Transformator
(Schaltschrank) | S5
5-Stufenschalter
(Schaltschrank) |



Wandmontage

des Rohrventilators **Typ RS** mit Haltebügel (HB)
 Befestigungsmaterial **nicht** im Lieferumfang enthalten!

Schritt 1

Montage Haltebügel (HB)

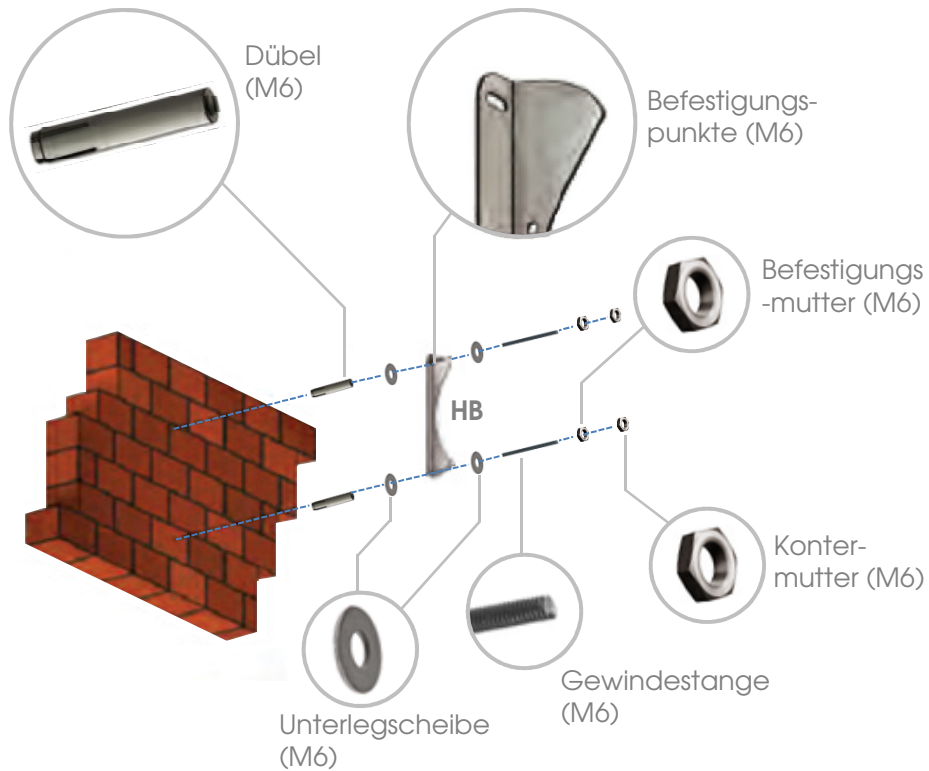

Schritt 2

Montage Kunststoff-Rohrventilator (RS)

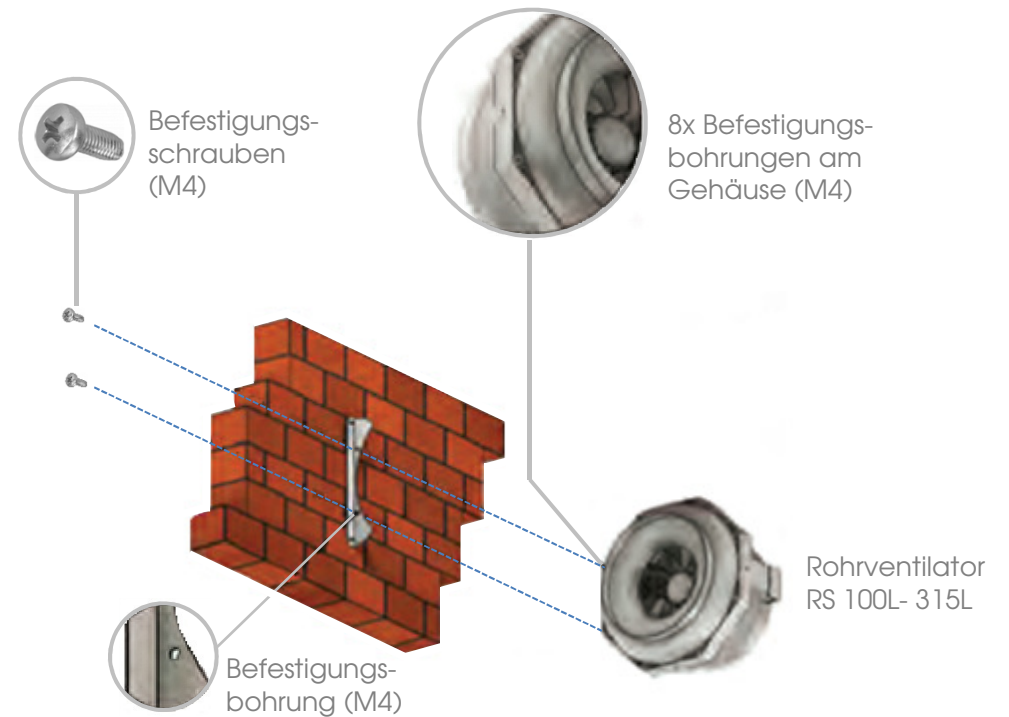



Deckenmontage

des Rohrventilators **Typ RS** mit Haltebügel (HB)
 Befestigungsmaterial **nicht** im Lieferumfang enthalten!

Schritt 1

Montage Haltebügel

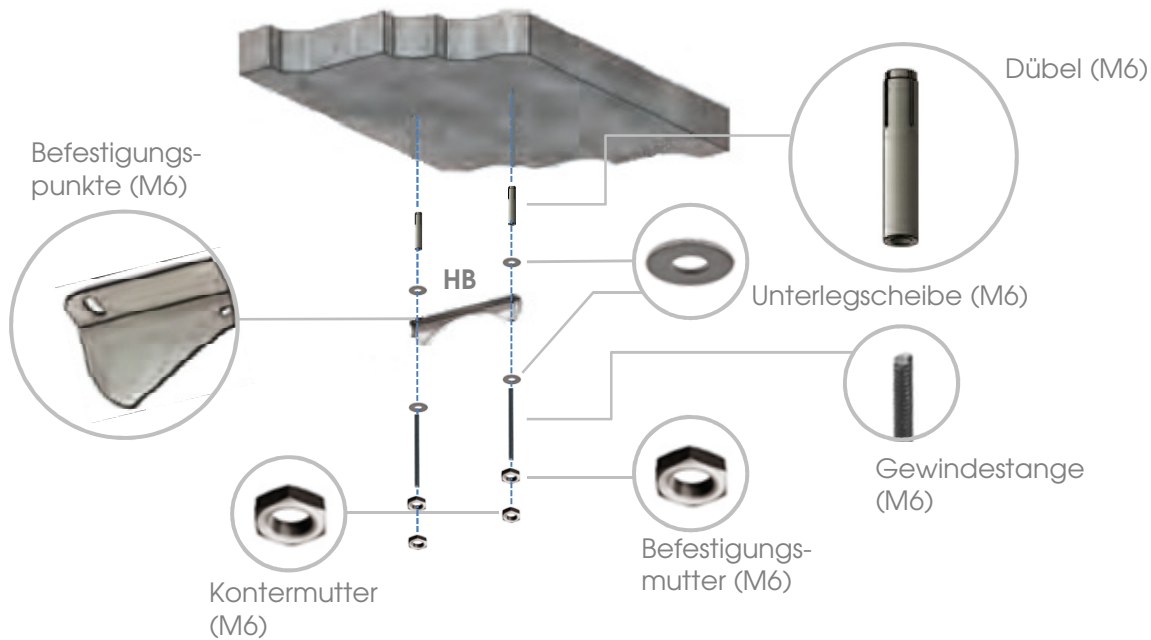

Schritt 2

Montage Kunststoff-Rohrventilator (RS)

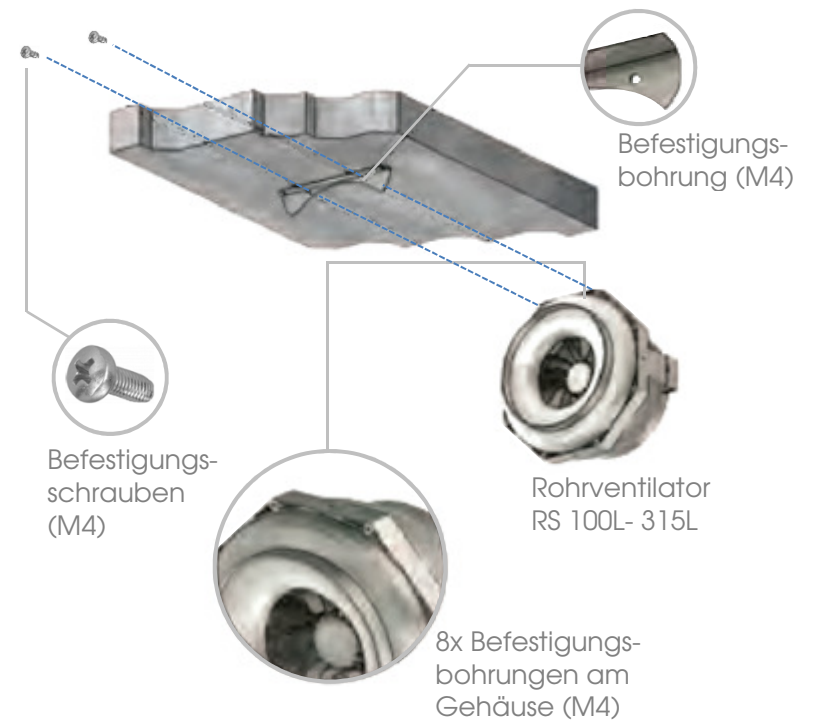



Wandmontage

des Rohrventilators **Typ R** mit Montagekonsole (MKA)
 Befestigungsmaterial **nicht** im Lieferumfang enthalten!

Schritt 1

Montage Montagekonsole (MKA)

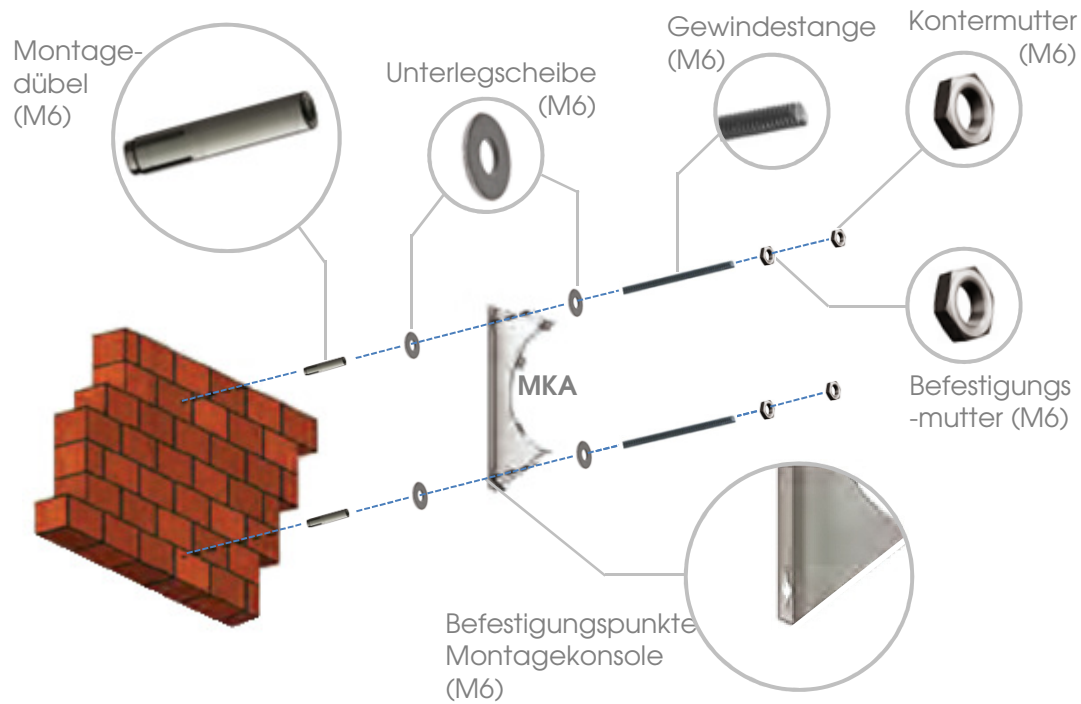

Schritt 2

Montage Rohrventilator (R)

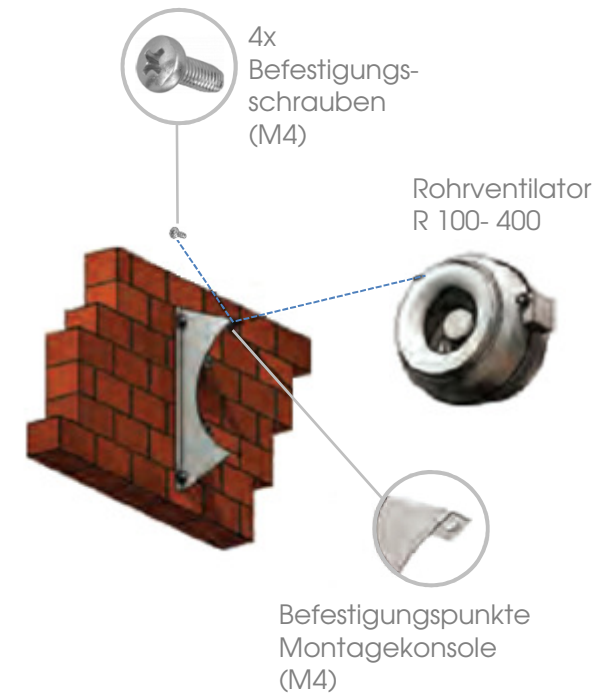



Deckenmontage

des Rohrventilators **Typ R** mit Montagekonsole (MKA)
 Befestigungsmaterial **nicht** im Lieferumfang enthalten!

Schritt 1

Montage Montagekonsole (MKA)

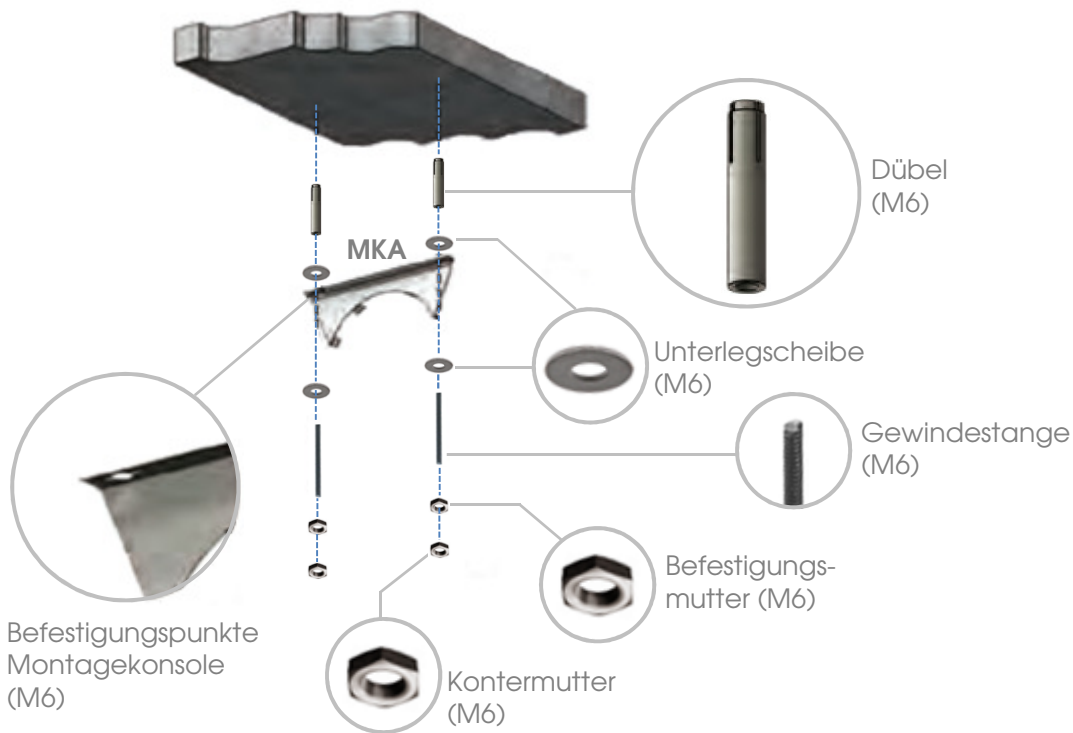

Schritt 2

Montage Rohrventilator (R)

